

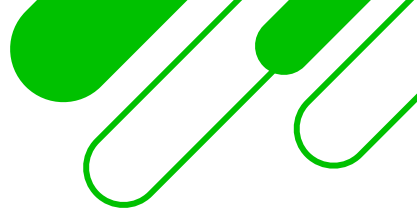

ARTIFICIAL GRASS SWEEPER

TM380-1800

INSTRUCTION MANUAL



Contents

Product overview	03
Packaging	04
Technical Specifications	04
Introduction	05
Features	05
Symbol	06
Purpose of use	07
Assembly Instructions	07
Setting Up	11
Product Operation	12
Replacing Brush Head	14
Safety Instructions	16
Maintenance	18
Warnings	19
Disposal	19

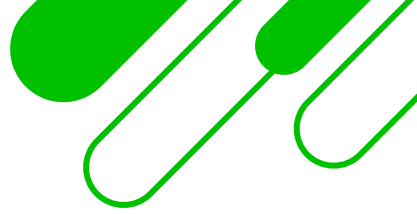

— Thank You! —

DEAR CUSTOMER

Thank you for purchasing **Turfmatic™ 380 Artificial Grass Sweeper 2 in 1 machine**. We always endeavor to bring you technology superior appliances, designed to let you live life on your terms.

Before you start working with the machine, read the following safety and usage instructions in this manual. Acquaint yourself with the operating elements and the correct use of the machine.

Save the original packaging, including the internal packing material, warranty card, and proof of purchase receipt at least for the duration of the warranty.

Following the instructions in the included user's manual is a prerequisite for the proper use of the machine. This user's manual also contains operating, maintenance, and repair instructions.

Keep the user's manual in a safe place where it can be easily retrieved for future use.

Pack this machine in the original cardboard box to ensure maximum protection during shipping or transport (e.g., when moving or when you need to send this product for repair).

NOTE: If you hand over the machine to somebody else, do so together with this user's manual. The manufacturer takes no responsibility for accidents or damages resulting from not following the instructions in this manual.

Product Overview:



- | | |
|------------------------------|--------------------------|
| 1. Main Switch Bar | 10. Basket Cover |
| 2. Main Switch Safety Button | 11. Basket Support Frame |
| 3. Power Cord | 12. Cable Retaining Clip |
| 4. Power Cord Retainer Hook | 13. Quick Release |
| 5. Top Section of Handle | 14. Bottom Handle Screw |
| 6. Middle Section of Handle | 15. Middle Handle Screw |
| 7. Bottom Section of handle | 16. Handle Angle Adjust |
| 8. Brush Depth Level Control | 17. Handle Washer |
| 9. Collection Basket | |

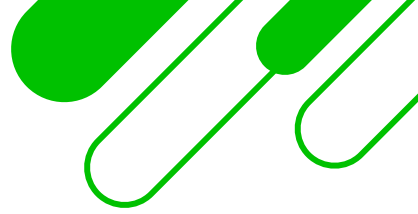

Packaging:

The product is packed in a package that prevents damage during transport. This package is a resource and so can be handed over for recycling.

Technical Specifications:

Electric Sweeper	Turfmatic 380-1800
Rated Power	1800W
Working Brush Width	38cm / 15"
Working Depth	+6 to -12mm / +2" to -5"
Collection basket capacity	48l / 12,5gal
Weight	12.6kg / 28lbs
Protection class	IPX4
Brush head operating speed	3500rpm
Sound pressure level	$L_{pA} = 85,56 \text{ db(A)}$ $K=3 \text{ db(A)}$
Guaranteed sound power level	$L_{wA} = 108 \text{ db(A)}$
Vibrations	$5,508 \text{ m/s}^2 K=1,5 \text{ m/s}^2$

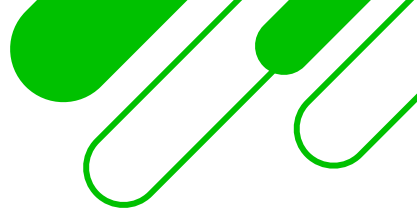

Introduction:







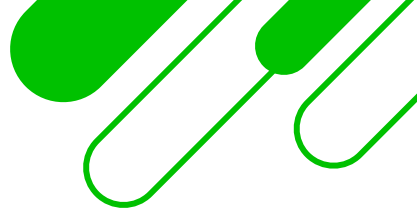

The Turfmatic™ 380 Artificial Grass Sweeper is exclusively designed for seasonal maintenance of Artificial Grass. It uses 15INCH brush head (built with Turfmatic™ Astrospiral Nylon) 4 height settings that allow the machine to be set for all styles of fake grass. It can easily pick up twigs, leaves, weeds, and items even as small as sunflower seeds while lifting any flattened area. Its 2 in 1 function allows for power brooming of the grass together with debris collection. The Turfmatic™ 380 Artificial Grass Sweeper increases the lifespan of the artificial grass and ensures it looks fresh all the time.

Features:

- Electric Motor Type
- Maximum power needed to run is 1800 watts
- IPX4 Protection
- 1 level forward speed
- Large 48L Collection Basket (12.5gal)
- Operating Speed 3500rpm
- 380mm Working Width (15")
- 12.6 kg Weight (28lbs)
- 1 Year Parts & Labour Warranty
- Turfmatic Designed Astrospiral Nylon Brush
- Handy and portable to carry



Symbols:

	<p>Attention! Before putting into operation, carefully read the user's manual and the general safety instructions!</p>
	<p>Do not work in the rain or in unfavorable climatic conditions!</p>
	<p>Attention, the brush of the sweeper continues to rotate for some time after it is turned off!</p>
	<p>Keep others a safe distance!</p>
	<p>Attention, rotating brush! Protect yourself against injury and loss of fingers.</p>
	<p>If the electric power cable has become jammed or is damaged, always turn off and pull the plug out of the electric power sockets!</p>
	<p>While working use protective aids.</p>
	<p>Before performing work on the machine, pull the power cord out of the electrical power socket.</p>

Purpose of Use:

The TM380-1800 is designed for sweeping lawns and grass areas in private gardens and yards. It is not intended for use in public facilities, parks, sports fields, on roads, or any agriculture uses.

ATTENTION! To prevent injury, the electric sweeper must not be used on garden borders, hedges, and bushes. Furthermore, the electric sweeper must not be used on uneven terrain or gravel surfaces.

Assembly Instructions

1. Attach the handle's bottom parts using the screw (14). Adjust the required handle (item 7) angle using the spline connector (16) as shown in the figure below;

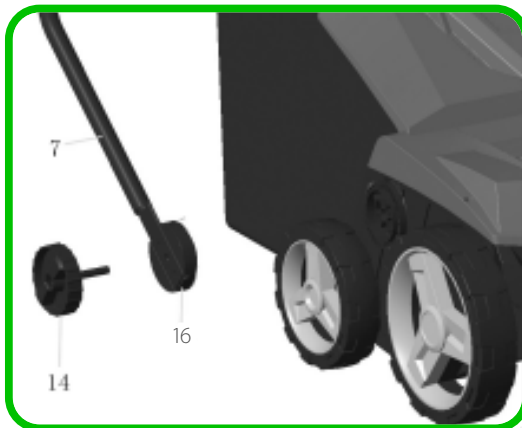

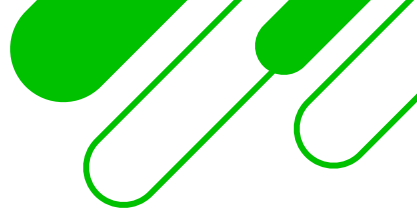

2. Screw on the handle's middle part with the power cord safety retainer clamp (4) attached using the quick release coupling and the handle screw (13).



3. Screw on the handle's top part as shown in the figure below;

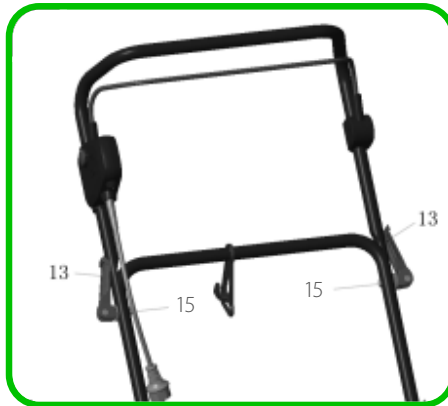

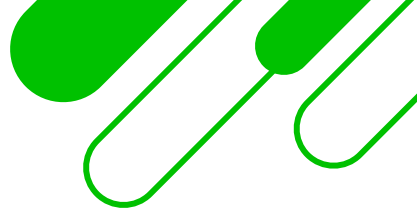

4. Attach the power cord to the handle using the retainer clips as shown in the figure below;

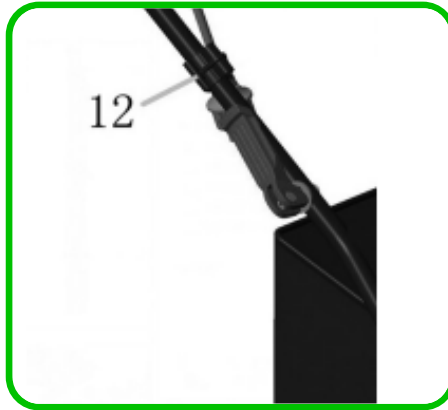

5. Place the steel frame (10) into the textile collection basket (9) and attach all fasteners to the left, right, and rear poles of the frame. Make sure that all fasteners are secured correctly as shown in the figure below;

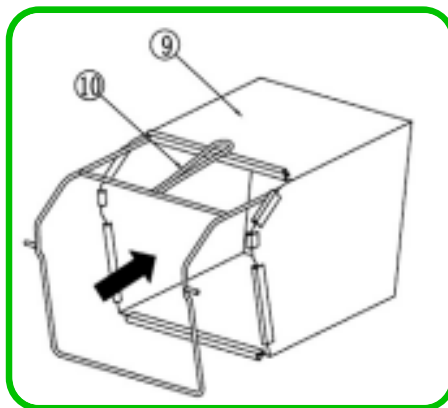

6. Installation of the completely assembled collection basket onto the sweeper
 - A. Lift up the protective cover.
 - B. Make sure that the ejection chute is clear and free of debris.
 - C. Place the fully assembled collection basket onto the fastening points in the rear part of the chassis, as shown.
 - D. Place the protective cover on top of the collection basket. Check that the collection basket is seated correctly WITH ITS BASE FLAT AND NOT TIPPING FORWARD.

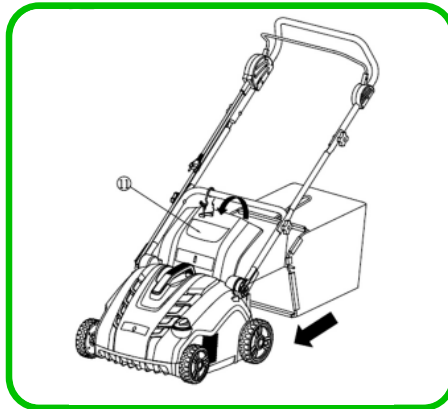

Note: The sweeper may be used without the collection basket with the protective cover in the lower position. This allows the sweeper to be used to lift flat blades of artificial grass back into an upright position. It is recommended to prolong the life of your artificial grass and keep it looking its best that this is carried out at least yearly. Use the lowest possible brush height setting without over stressing the motor. It is recommended that run time does not exceed 20 minutes of continuous use.

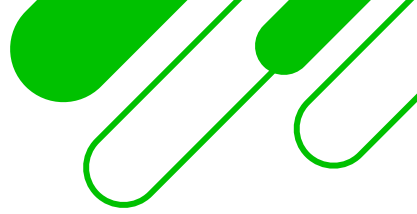

Setting Up:

ATTENTION!

The working depth of the brush head should always be set to the minimum required to lift up the blades of artificial grass. This will depend on the height of the grass and degree of flattening. It may be necessary to reduce the brush depth after the first pass as the grass blades begin to lift. Setting an excessive working depth may result in damage to the brush head cylinder or the overloading and destruction of the motor. The lawn may also be damaged.

Adjustment after wear:

To maintain the recommended working depth, use the depth adjustment control (fig. 1, item 8).

Note: The brush head of the sweeper wear out depending on the manner in which they are used. The more intensively the sweeper is used, the greater the wear on the brush head.

The sweeper brush head is replaceable part and is Not covered as part of any warranty on the machine.

Product Operation:

Before starting up the sweeper, check that the brush has come to a complete stop. Do not turn on and off in rapid succession.

Starting:

1. Press and hold the safety button 1. Pull the starting lever 2 towards the handle.
2. Release the safety button.

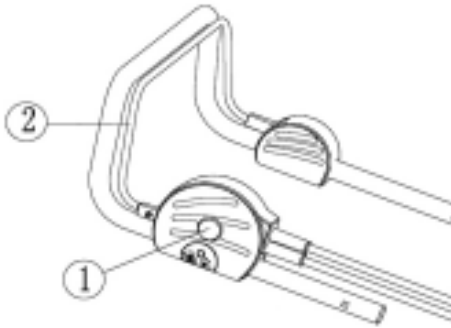

Turning off:

Release the starting lever 2



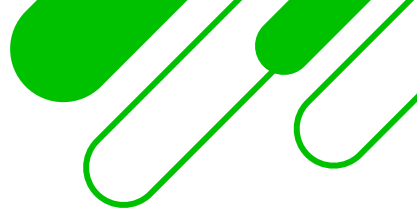

Sweeping / Powerbrooming:

- For comfortable work with the sweeper, it is best to start working at the location closest to the power source and to proceed away from the power source.
- Sweep the lawn at a right angle from the power source and place the power cord on the side that has already been swept.

ATTENTION! Do not place too much strain on the motor when working, especially in demanding conditions. When the motor is put under strain, the motor speed will decline and you will hear a change in the noise of the motor. Whenever this happens, stop working, release the starting lever, and reduce the brush depth. Otherwise, the machine could be damaged.

NOTE: The motor is protected by a safety mechanism that is activated at the instant that the brush is caught or the engine is overloaded. Whenever this occurs, turn the machine off and pull the power plug out of the power source. The safety mechanism will reset only when the starting lever is released. Remove all obstructions and wait several minutes before resetting the safety mechanism and resuming work. At this point, do not play with the starting lever as this will extend the safety mechanism reset time. In the event that the machine turns off again, raise the height of brush depth again, which in turn will reduce the load on the motor further.

Replacing Brush Head:

DANGER! The brush head may cause injuries!

Prior to replacement, disconnect the machine from the power supply and wait for the brush to come to a stop. When replacing the brush head, wear heavy-duty gloves.

1. Screw out bolt 1 on the underside of the chassis.

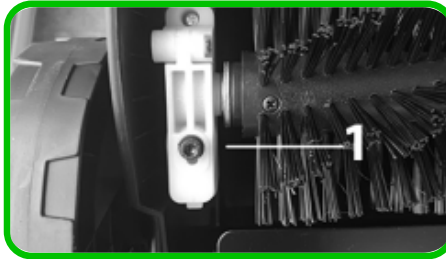

2. Lift the brush at an angle and pull it out.

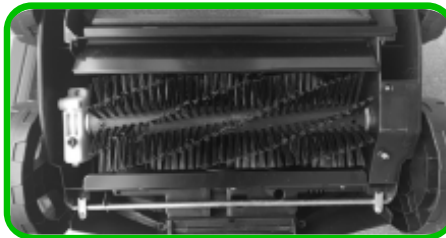

3. Slide the replacement brush on to the drive shaft so that pin 5 fits into the respective part of the drive shaft 4.

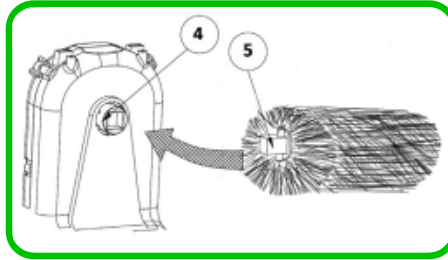

4. Retighten screw 1 to secure the brush.

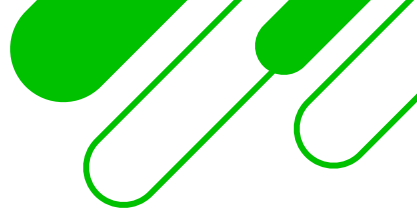

Safety Instructions:

- Carefully unpack the product and take care not to throw away any part of the packaging before you find all the parts of the product.
- Store the product in a dry place out of reach of children.
- Work only under good visibility.
- Do not place hands or feet near the brush head.
- Do not open the rear cover during use.
- Acquaint yourself with the surroundings of your work area. Check for potential dangers, which may not be audible due to the noise of the machine.
- Wear solid footwear and long trousers to protect your legs.
- Make sure that your legs are at a sufficient distance from moving parts.
- Make sure that there are no other people (particularly children) or animals in the work area.
- Always push the artificial grass sweeper at walking speed.
- Operating position: make sure that you have safe foot support during operation.
- Be careful when changing direction on a sloped area.
- Read all warnings and instructions in this manual as not following the instructions may lead to injury by electrical shock, a fire, and/or other serious injuries.

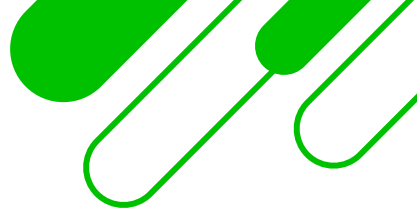

- You are responsible for the safety methods of use described in these instructions.

Electrical safety:

- Keep the extension cord away from the brush cylinder!
- Never use the electric sweeper in the rain.
- Please adhere to local residential noise restrictions.
- Regularly inspect the power/extension cord for damage and signs of wear and tear.
- In the event that the power/extension cord is damaged, immediately unplug the power cord.
- The extension cord must be water-resistant providing protection against spraying water, or the power sockets for the extension cord must be made from rubber or must have a rubber cover.
- Any extension cords must meet the requirements of local electrical standards.
- Only use approved extension cords with the corresponding conductor cross-sections. Please consult your electrician.
- It is necessary to use connecting accessories for the extension cord.
- For portable equipment used outdoors, we recommend the use of a residual current device with a maximum current rating of 30 mA.

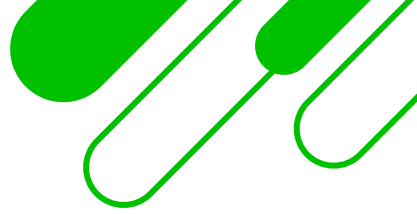

ATTENTION! Be careful when walking backward. You could stumble!

Note: When you stop using the machine, place it in a safe location. Unplug the power plug! If you stop working in order to move to a different work location, always turn the power off while carrying it. Move the height adjustment lever to its highest transport position.

In the event that you hit an object while sweeping, always turn off the electric before attempting to remove the object from the brush.

Maintenance:

- Prior to maintenance, disconnect the machine from the power supply and wait for the brush head cylinder to come to a stop.
- While performing maintenance use work gloves.
- The sweeper should be cleaned after every use.
- Do not clean the sweeper under running water (Do not pressure wash).
- Do not use hard or pointed items for cleaning the sweeper.
- Regularly remove accumulated debris from the wheels, brush head cylinder, and cover.
- Regularly check the electric sweeper for foreign object damage and have it repaired if necessary.

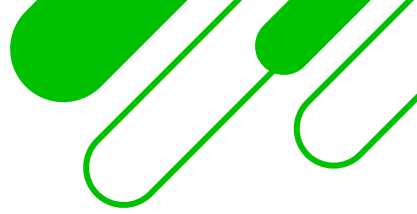

Warnings:

- A rotating brush may cause injuries.
- Risk of injury and material damage.
- Do not use the electric sweeper in the rain or in damp or wet conditions.
- Do not work with the sweeper near the edges of swimming pools or garden ponds.
- Please adhere to all local restrictions related to noise levels. Never leave the electric sweeper in the work area without supervision.

Warranty:

1- Year Limited Lifetime Warranty

The original purchaser for this unit is provided with a 1-YEAR WARRANTY.

Covered Under Warranty:

The warranty begins from the date of purchase. For the first year, coverage is for both parts and labour on warranty repair services.

Note: Customers have to provide proof of purchase to initiate the repair work under warranty. We strongly recommend keeping the original receipt.

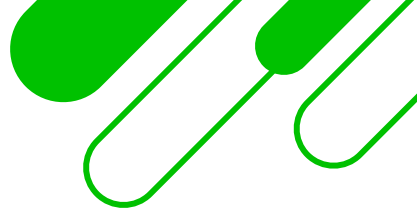

Not Covered Under Warranty:

- 1.** We do not offer a warranty for products that have been bought secondhand or as a resold product.
- 2.** Issues of replacement and refunds on units purchased less than 30 days from an authorized dealer must be addressed to the dealer directly.
- 3.** If the products purchased from an authorized dealer are after 30 days from the date of purchase, please send the units to us for service and repair.
- 4.** We do not cover the cost of repairs and replacements due to misuse by the owner's improper maintenance, and/or lost units.
- 5.** Any water damage on the product will not be covered.
- 8.** All replacement costs for either the brush head or other parts will be the owner's responsibility.
- 9.** The warranty is void if the unit has been altered or an unauthorized person has damaged the unit while attempting repair work.
- 10.** We reserve the right to retain and discard any part or accessories that have been found damaged upon replacement and repair.

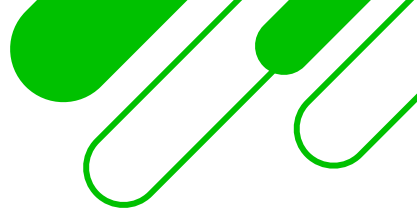

Disposal:

INSTRUCTIONS AND INFORMATION REGARDING THE DISPOSAL OF USED PACKAGING MATERIALS

Dispose of used packaging material at a site designated for waste in your municipality.



The power tool and its accessories are manufactured from various materials, e.g., metal and plastic. Take damaged parts to a recycling centre. Inquire at the relevant government department.



This product meets all the basic requirements of EU directives that apply to it.

Changes in the text, design, and technical specifications may be made without prior notice and we reserve the right to make these changes.